



Outstanding in our field — Outstanding in yours



2011

Baseball & Softball Products

- Batting Cages
- Suspended Batting Cages
- Protective Screens & Netting
- Windscreen
- Custom Netting
- Pitching Machines
- Field Maintenance
- Protective Padding
- Field Protection
- Portable Pitching Mounds

1-800-955-NETS (6387)
www.supernetsusa.com



Message from the President

At Super-Net we consider ourselves the tenth player on the field. As a team player, we listen to coaches and strive to give them what they want. The wisdom of having the right tools for the job can help a good team become a great team.

Super-Net was founded by a former head coach when he was unable to get the practice gear he needed. Since then, Super-Net

has grown into a leading provider of practice equipment to major and minor league teams, colleges and universities, and schools and recreation associations for the past 33 years.

Our batting cages and nets are built in house and can be custom designed to fit the needs of the facility and the needs of the coaches and players.

We carry a full range of baseball and softball related items—from batting cages to pitching machines to protective netting and screens. We also provide field maintenance equipment from mats to tamps to bases.

At Super-Net, our personal approach to service and our goal to provide the best quality at the most reasonable price is our company philosophy. Our greatest pride comes in our ability to give you, the customer, exactly what you want.

Please browse our catalog or web site www.supernetsusa.com and you will see that Super-Net can save you valuable time and money by being able to provide one-stop shopping for your team practice and facility needs. Don't hesitate to call if you have questions. We're here to help!

Glen H. Passner

Terms & Conditions of Sale

To order: Orders can be placed by phone, mail, online, or fax. All prices are FOB Fuquay-Varina, NC or manufacturer unless otherwise indicated. Current prices apply at time of shipment unless otherwise quoted. Catalog prices are subject to change without notice.

Terms: Net 30 days from date of invoice to schools, government agencies, and those with approved credit. Master Card, Visa, and American Express accepted. For private organizations, we require payment by Master Card, Visa, American Express or prepayment. 1 1/2% per month finance charge will be imposed on all invoices 10 days past the original due date.

Freight: We ship freight prepaid and add the shipping charges to your invoice unless otherwise agreed. We ship the most convenient and cost-effective way for our customers. Customer pickup is also offered from our warehouse in Fuquay-Varina, NC.

Sales Tax: We are required to collect sales tax only from North Carolina, Indiana and New Jersey customers who are not tax exempt. An exempt certificate is required from all exempt customers.

Damage: All freight must be inspected for damage or shortage immediately upon delivery. If damage or shortages occur during shipment, circumstances must be noted on the bill of lading. This is necessary so that proper damage claims can be made against the carrier. Hidden damage must be reported within 5 days of delivery date directly to the carrier. Failure to do so will forfeit any claims for damage with Super-Net.

Returns: We require prior authorization for all returns. 20% re-stocking charge on all returns. All returns must be made within 30 days and authorized by Super-Net. Please call for an R.A. number. Any return without an R.A. number will not be accepted. Custom nets cannot be returned.

Table Of Contents

Batting Cages	3	Enduro Fencing	17
Backyard Batting Cages	4	Field Maintenance Equipment	18-21
Heavy-Duty Vinyl Net Saver Backdrops	4	Poly Cap	22
Ball Hopper.....	6	Fence Guard	22
Protective Screens.....	5-7	Outfield Distance Markers	22
Replacement Nets	8	Field Protection	23-24
Protective Netting	9	Radar Guns	24
Custom Banners	9	Wall Pads	25
Windscreening	10	Artificial Turf Mats	26
Sports Cage Installations	11-12	Pitching Mounds & Mats	27-28
Suspended Cage System	13	Batting Practice Platform	28
Floor Protection	13	Softball Pitching Mats	28
Portable Batting Cage	14	Bases	29, 30
Pitching Machines	15-16	Bleachers	31
Pitching Machine Balls	16	Benches	31



Photo courtesy of Steelmaster Buildings, The Ultimate Arch Steel Building Co. 1-800-341-7007. www.steelmasterusa.com

All Super-Net Cages are constructed of heavy-duty knotted nylon and bound on all sides with 5/16" rope. A 3/8" rope runs down the middle of the top of 10' and wider cages. Outdoor cages use black netting for weather resistance and indoor cages can be made all black, white with black ends, or black with white top.

Custom Batting/Golf Cage Net Price List

Custom sizes available upon request. Super-Net will custom make any size cage.

Size	Knotless	Economy	Knotted	Knotted
H x W x L	#420 7/8"	#21 1-7/8"	#36 1-7/8"	#60 1-7/8"
	Baseball, Softball, Golf	Baseball, Softball	Baseball, Softball	Baseball, Softball
10 x 10 x 35	\$534.00	\$332.00	\$420.00	\$810.00
10 x 10 x 55	\$773.00	\$492.00	\$620.00	\$1200.00
10 x 10 x 70	\$956.00	\$610.00	\$770.00	\$1495.00
10 x 10 x 75	\$1013.00	\$631.00	\$820.00	\$1590.00
10 x 12 x 55	\$842.00	\$515.00	\$690.00	\$1300.00
10 x 12 x 70	\$1029.00	\$655.00	\$830.00	\$1580.00
10 x 12 x 75	\$1104.00	\$700.00	\$885.00	\$1680.00
12 x 12 x 55	\$951.00	\$605.00	\$760.00	\$1450.00
12 x 12 x 70	\$1167.00	\$745.00	\$940.00	\$1795.00
12 x 12 x 75	\$1242.00	795.00	\$989.00	\$1910.00
12 x 14 x 55	\$1018.00	\$645.00	\$820.00	\$1550.00
12 x 14 x 70	\$1248.00	\$795.00	\$999.00	\$1915.00
12 x 14 x 75	\$1325.00	\$845.00	\$1075.00	\$2025.00
14 x 14 x 70	\$1390.00	\$880.00	\$1120.00	\$2099.00
14 x 14 x 75	\$1472.00	\$940.00	\$1175.00	\$2230.00

Many other weights of netting available on request including #30 and #42.

Outdoor Batting Cage Frames

Super-Net's Galvanized Steel Batting Cage Frames

Frames come complete with cross bars, vertical poles and ground sleeves. Net is attached to frame using spring hooks and chain for easy adjustment of net.

Heavy-Duty Frames

55' long cage frames (4 sections) Model #HVYFRAME55 \$775.00

70' long cage frames (5 sections) Model #HVYFRAME70 \$950.00

Backyard Batting Cages

Our Backyard Batting Cage has a functional design, is durable and quick and easy to setup. Great for indoor or outdoor use; lightweight and portable if desired. The Under The Frame Net Cage Model uses 1 3/8" fence top rail material. Use pipe you purchase locally and we provide all the other parts needed including the net.



Under The Frame Cage

#21 10'h x 10'w x 40'l

Model #UTCM40

\$450.00

#21 10'h x 10'w x 70'l

Model #UTCM70

\$775.00

4' cage requires 23 pc. poles

7' cage requires 38 pc. poles

Heavy-Duty Vinyl Net Saver Backdrops



These heavy-duty 22 oz. vinyl backdrops help save your batting cages from the holes that come from repeated use. This attractive money-saver comes in a variety of colors and easily attaches to the back of your batting cage. All backdrops come with a sleeve and grommets across the top and grommets in both bottom corners. Available in green, yellow, blue, red, black, and white.

Add \$25.00 for window pane strike zone graphic.



Size	Model #	Price	Size	Model #	Price
6' x 6'	VINYLBKST6	\$65	10' x 10'	VINYLBKST10	\$125
7' x 7'	VINYLBKST7	\$70	10' x 12'	VINBACKST10x12	\$145
8' x 8'	VINYLBKST8	\$80	12' x 12'	VINYLBKST12	\$178
9' x 9'	VINYLBKST9	\$99	14' x 14'	VINYLBKST14	\$240

Custom sizes are available. Call for a quote.



22 oz. vinyl-coated cover protects your cage and provides graphic strike zone for your pitchers. Backdrop protector comes in attractive colors: Forest Green, Royal Blue and Red with white strike zone. Includes four poly ropes for easy attachment. 7'h x 5'w

Model#BCBP

\$132.00

Also available in 30oz. Navy Blue heavy duty vinyl with yellow strike zone. (Shown at left)

Model#BCBP27

\$145.00

Professional Protective Screens

Combine the quality of 1-3/4" aluminum tubing with a .125 wall, all welded and gusseted construction for strength and #42 knotted slip-on netting with the convenience of no assembly and roll-out capability, and you have the best protective screening for all levels of play.



First Base Screen 8'h x 8'w (w/wheels)
Model #PROFBW \$499.00



"I" Screen 8'h x 8'w (w/wheels)
Model #PROLW \$499.00



Soft Toss Screen 6'h x 6'w
Model #PROST \$399.00



Second Base Screen 8'h x 14'w (w/wheels)
Model #PROSBW \$799.00

Custom screens and padding available.
Please call for pricing.

Protective Screens

When you need equipment that will last, day in and day out, Super-Net has your screens. We have developed the best protective screens on the market. They're extra strong 1-3/4" O.D. aluminum with a 1/8" thick wall, but extremely light-weight for easy handling. Easily assembled with spring button connectors, our screens can be taken apart in a few minutes for storage. The black net slips over the frame, like a pillowcase, using a double thickness of #42 twine netting.



Spring buttons for easy assembly



Softball Protector
4'w x 6-1/2'h with 7" w x 27" h cutout
Model #SB-P **\$235.00**



"L" Protector
6-1/2'w x 6-1/2'h with 32" w x 32" h cutout
Model #LPS **\$235.00**

Little League Version
6-1/2'w x 6-1/2'h with 32" w x 46" h cutout
Model #LPS2 **\$235.00**



Field Protector 6-1/2'w x 6-1/2'h
Model #FPS **\$235.00**

Field Protector 8'w x 6-1/2'h
Model #FPS-2 **\$250.00**



Back Saver Ball Bin
This waist-high ball bin is the perfect height for live pitching practice and seated soft toss. Can be folded, trapping balls during transport, reducing storage space. Holds over 100 baseballs or 50 softballs.
Model #BSBB **\$85.99**

Mesh Ball Bag
Clips to net. Holds 3 dozen baseballs.
Model #MBS **\$15.00**



Back Saver Ball Caddy
10" dia. pneumatic tires roll easily over uneven turf and wet infield clay. Constructed from heavy wall, galvanized steel tubing. Holds 300 baseballs/150 softballs. 45" tall, 29" wheelbase, extends forward 24".
Model #ASBC **\$279.00**



Ball Hopper
Three eight adjustments: 24", 30", 36". Holds 84 baseballs and 60 softballs. Hopper is constructed of 18 oz. vinyl with heavy mesh on two sides and bottom. Galvanized steel base.
Model #BSBB **\$89.00**

Soft Toss or Tee Screens

(Screens have pocket net)



Machine or Fungo Screen 4'w x 6-1/2'h
Model #MFS \$235.00



Machine or Fungo Screen 5'w x 5-1/2'h
Model #STS1 \$235.00



4'w x 6-1/2'h
Model #STS \$235.00



6-1/2'w x 6-1/2'h
Model #STS2 \$235.00

Protective Screens



Jugs Short-Toss Screen

Soft toss screen provides overhead protection from ricocheted balls. Made of 1 5/8" power-coated steel tubing, with a #60 pillow-case style polyethylene net. Screen bolts together for easy assembly.

Model #JSHORTTOSS

\$199.00



Home Plate Batting Practice Cage

- 1 3/4" O.D. aluminum, with spring button connectors
- Cage is 10'h x 14'w x 14'd
- Netting is #36 twine roped with black 5/16" polypropylene rope border.
- Plastic ties for attachment of net.

Model #HPBPC

\$1050.00

Slip-On Replacement Nets

A Super-Net original, the “Slip-On Net” gives you double protective strength. All you do is slip it on over your frame, and you’re ready to practice—no roping or attaching required. The nets are made of #36 weatherized knotted nylon, finished all around with 5/16” black polypropylene rope. Plus, Super-Net will custom-make any size, and any shape. Call us with your specifications, and we’ll get started!

There’s no substitute for the original slip-on replacement net!

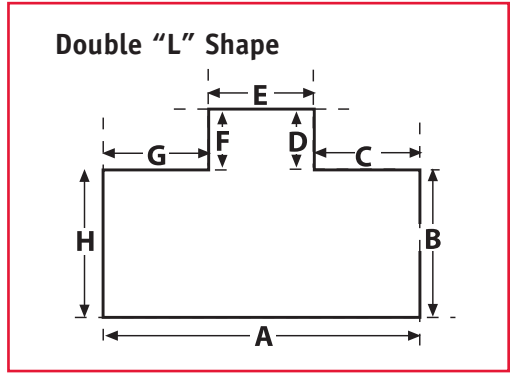
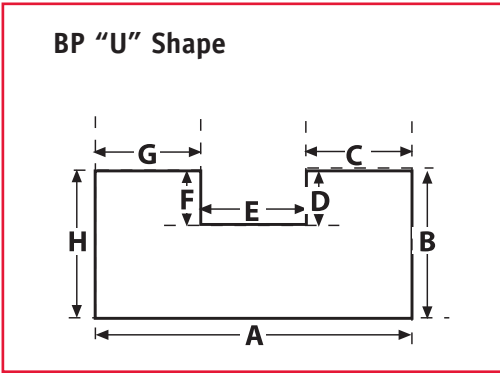
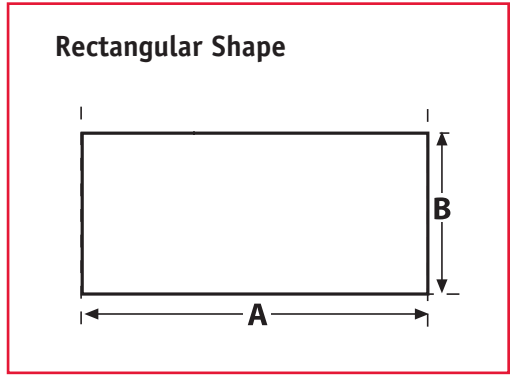
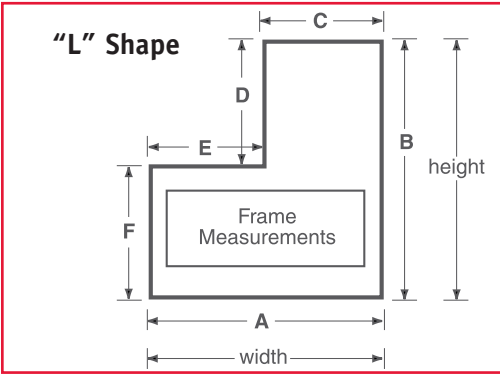

Fill in your Frame Measurements for Replacements Net

Shape	A	B	C	D	E	F	G	H
“L” Shape								
Rectangular								
BP “U” Shape								
Double “L” Shape								

Sample Prices—Rectangular & “L” Shape		
Width x Height	Model #	Price
6’ x 6’	SON6	\$60
6’6” x 6’6”	SON6.5	\$65
7’ x 7’	SON7	\$70
7’6” x 7’6”	SON7.5	\$75
8’ x 8’	SON8	\$80
9’ x 9’	SON9	\$95
10’ x 10’	SON10	\$100



Net Repair Twine Kit

Great for repairing batting cages. 550’ of #36 twine with sewing needle.

Model #TWINEKIT **\$9.50**

Twine Kit plus 10’ sq. of netting.
Model #TWINEKITPLUS **\$38.00**

Protective Netting



Super-Net offers a complete line of custom protective netting for all purposes. From backstop netting, home-run fences, sideline netting, soft toss netting, spectator protection, foulball netting, golf range barrier netting, to football goal post netting. We offer a wide selection of weights, types, and mesh sizes. All netting is fully weather treated and UV protected and is custom made to your size requirements. Call today for special pricing on larger orders.



Size	Style	Model #	Price Per Sq. Ft.
7/8"	252	PN25278	39¢
7/8"	420	PN42078	50¢
1-3/16"	504	PN5041316	47¢
1-7/8"	504	PN504178	46¢
4"	504	PN5044	36¢
1-7/8"	21	PN21178	28¢
1-7/8"	30	PN30178	35¢
1-7/8"	36	PN36178	39¢
1-7/8"	42	PN42178	47¢
1-7/8"	60	PN60178	62¢
2"	96	PN962	\$1.85

Custom Banners



Custom Banners

Silk screened and digitally printed banners on vinyl or windscreen. Call for prices.



Windscreening

14 Oz. Vinyl Windscreening

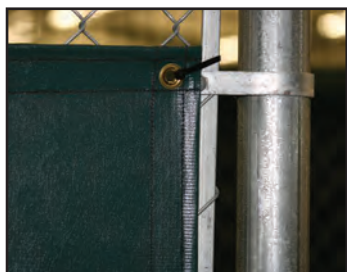

Heavy duty 14 oz. windscreening offers complete privacy and wind block. vinyl windscreen is very durable and comes in Green, Yellow, Blue, Black, Red and White. 6' or 9' high. (Custom sizes available.)

Windscreening	Product ID #	Price per sq. ft.
6'	14ozvwind6	61¢
9'	14ozvwind9	65¢

Warning: Solid vinyl windscreen is not recommended for windy areas or light duty fences.

Polypropylene Windscreening



Polypropylene windscreen has been the standard for many years. Available in open mesh (leno) or closed mesh. Both styles are very durable. All windscreens are bordered with a sewn edge and grommets all around. 6' and 9' heights are standard. Super-Net can custom make other sizes. Colors: Dark Green or Black.

Windscreening	Product ID #	Price per sq. ft.
6' Open Mesh (LENO)	WS06	59¢
6' Close Mesh	WSC6	62¢
9' Open Mesh (LENO)	WS09	59¢
9' Close Mesh	WSC9	62¢

Vinyl-Coated PVC Windscreening



Heavy-duty vinyl coated polyester windscreen is available in 11 colors. Windscreen can be either 6' high or 9' high (9' comes with center tape). Grommets are placed at 18" all around the edges. Colors available: Forest Green, Kelly Green, Orange, Yellow, Red, Royal Blue, Navy, Black, White, Gray, Brown, Maroon, Carolina Blue, Tan and Purple.

Windscreening	Product ID #	Price per sq. ft.
6'	WSPVC6	57¢
9'	WSPVC9	61¢

Do-it-Yourself Windscreening



This new knitted 100% polyethylene windscreen material has a super strong border which requires no grommets. Simply cut the screen to your required length and attach to your fence with cord or wire ties. Available in 6' (70") high and 9' (106") high at a length of 150'. Color available Dark Green.

Windscreening	Product ID #	150 ft. length
6'	DITYWS6	\$190.00
9'	DITYWS9	\$289.00
Plastic Tie Wraps 100pc	DITYWTIES	\$10.00

Ceiling Hung Parallel Cable Kit

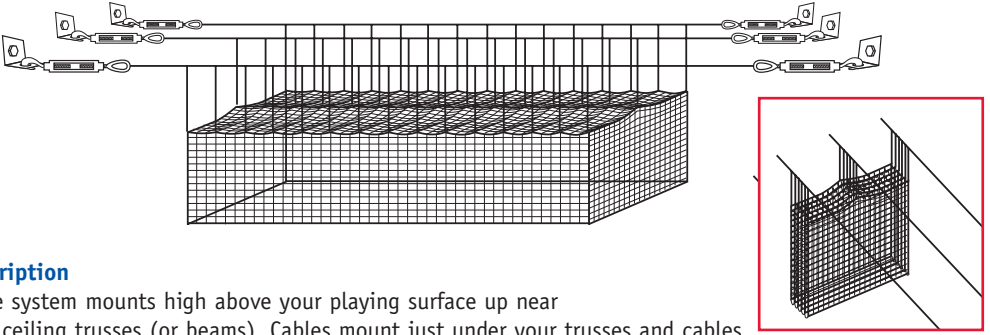

Description

Cable system mounts high above your playing surface up near your ceiling trusses (or beams). Cables mount just under your trusses and cables are hung downward vertically to the height of net. Spring snaps are provided to attach the net. On the top end of the vertical cables, we provide trolleys that enable you to easily slide the cage back and forth onto the playing surface or out of the way.

Kit includes all of the hardware for a complete installation;

- complete instructions
- (6) wall brackets and rear mounting plates,
- threaded rod
- 1/8" cable (1000 LF)
- (96) wire rope clips
- (6) thimbles
- (42) trolleys
- (84) spring snaps
- (6) turnbuckles

Advantages

1. Simple to install.
2. Support system always ready.
3. Cables are mounted high above the playing floor just below the truss line, high out of the way of other activities.
4. Net slides easily back and forth on pulleys for convenient handling and storage.

Model #CHPCK (Complete Kit)

\$399.00

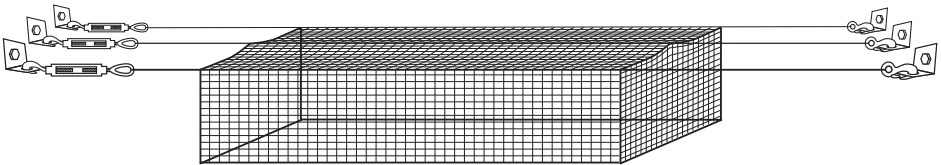

Three Parallel Cables
(recommended for 10' wide or wider net.)

Model #PCS three cable & hardware (Complete Kit)

\$225.00

Description

Cable system mounts at the height of the net (i.e. 10', 12', 14') wall to wall enabling you to slide your net to one end or the other for storage when not in use. Kit includes all the hardware for complete installation;

- complete instructions
- (6) wall brackets & rear mounting plates,
- threaded rod
- 1/8" cable (300')
- (3) turnbuckles
- (3) safety hooks
- (105) spring snaps
- (12) wire rope clips
- (6) thimbles

Advantages

1. Simple to install.
2. Support system always ready.
3. Net can slide to either end for storage.
4. Clear floor usage – cable doesn't interfere with floor activities.

Batting Cage Installations

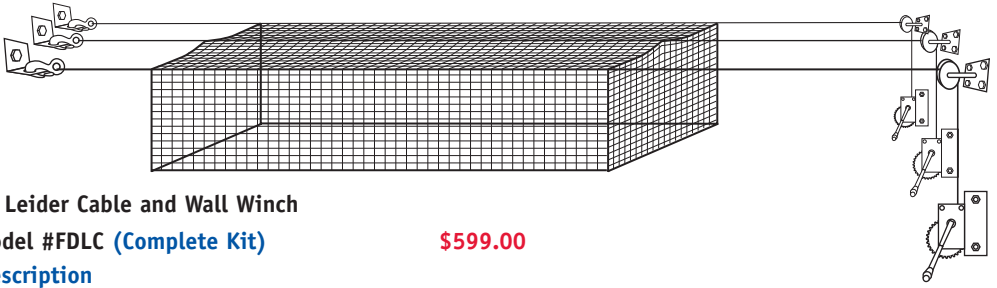

Ed Leider Cable and Wall Winch

Model #FDLC (Complete Kit) \$599.00

Description

Cage system is suspended on three parallel cables. One end of the cable has a hook attached to wall-mounting plate. The other end passes through a pulley and is attached to a take-up winch. Winches control cable tension. Net is suspended from cables and, when not in use, can be temporarily stored, sliding like a shower curtain, to either end of the room.

If cables have to be temporarily taken down for another activity (1) net is stored only on the pulley side, (2) cable slacked off, (3) hooks unhooked, (4) cable is cranked completely on the winch except for the last 10/12', (5) left cable is then attached to right pulley & vice versa, supporting the net against the wall.

Kit includes:

- complete instructions
- (3) winches
- (3) pieces of 1/8" cable
- (3) thimbles
- (1)05 spring snaps
- (6) wire clips
- (6) wall brackets & rear plates
- threaded rod
- (3) safety hooks

Advantages

1. Simple to install
2. Tension can be quickly adjusted
3. Net can slide to either side for storage, similar to a shower curtain
4. Clear floor usage-cable does not interfere with floor activities
5. Net can be attached when cable tension is lowered to floor; height tension is increased as net is raised into operational position
6. When net is stored on side of winches, cable can be unhooked, cranked back and stored away so gym area is completely clear

Installation Hardware

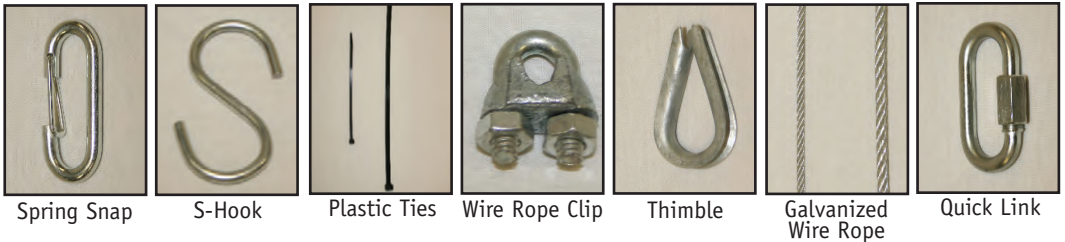

Spring Snap

S-Hook

Plastic Ties

Wire Rope Clip

Thimble

Galvanized Wire Rope

Quick Link



Galvanized Turnbuckle



Wire Rope Cutters

Most Common Methods of Mounting Cages to Cable System

Item	Model #	Price
Spring Snap	Model #SPRNGSNP	60¢
"S" Hook	Model #SHOOK	20¢
Plastic Tie-5.5"	Model #PLAST5.5	8¢
Plastic Tie-10"	Model #PLAST10	20¢
1/8 Wire Rope Clips	Model #WR18	25¢/ea.
3/16 Wire Rope Clips	Model #WR316	30¢/ea.
1/8 Thimbles	Model #TH18	24¢/ea.
3/16 Thimbles	Model # H18	35¢/ea.
1/8 Galvanized Cable 7x19	Model #GC18	20¢/LF
3/16 Galvanized Cable 7x19	Model #GC316	30¢/LF
5/16 Quick Links	Model #QL516	90¢/ea.
Turnbuckles Galvanized-3/8 x 6 Hook & Eye	Model #TBG386	\$6.00
Wire Rope Cutters; Cuts 1/8" & 3/16" cable	Model #CUTTER	\$24.95

Suspended Cage System

For the ultimate in installations, try our Suspended Batting Cage system. The cage stores in the ceiling out of the way and lowers when you are ready to use it. Nothing but the net touches the floor. Call Super-Net today. Don't let anything get in the way of your game!



Batting cage is suspended from 1-3/4" O.D. aluminum frame with reinforced fittings to fit the size cage desired. Comes complete with nylon ties, heavy-duty pulleys, beam clamps, electric motor or a manual winch and 1/8" aircraft cable. Super-Net needs detailed structural information before shipping. Call: 1-800-955-NETS to discuss your installation.

Electric winch

Model #SCFE

\$3999.00

Remote Control Unit for electric winch

Model #RCU

\$360.00

Installation & Batting Cage Net not included in price.

Floor Protection

Protect your gym floor from scratches, scuff marks, and stains. Available in three different weights. All seams are heat sealed for extra strength and to lay flat. Super-Net can make any size cover.

14 oz. vinyl

Model# FLOORPROTECT14

60¢/sq.ft.

Colors: navy, red, gray, forest green, purple, orange, tan, maroon, yellow, light blue, black, Kelly green.

19 oz. vinyl

Model# FLOORPROTECT19

85¢/sq.ft.

Colors: tan, light gray, royal blue, red, dark green.

22 oz. vinyl

Model# FLOORPROTECT22

90¢/sq.ft.

Colors: tan, light gray, royal blue, red, dark green.



Call for roller pricing.

www.supernetsusa.com

Portable Batting Cages



Express Cage

- Constructed of 2" heavy-wall aluminum tubing
- Heavy duty weather treated netting
- Heavy duty vinyl coated nylon skirt
- Quickly collapses to 5'h
- Dual coaches' observation platforms
- 18" h x 8" w pneumatic tires
- 4" thick thud pad
- Padding on all overhead framework
- Measures 18'w x 22'd x 12'h

Model #EXPRESSC

\$4199.99



Big League

Professional style batting cage for all levels of use. Easy to assemble, set-up and move. Big League comes with exclusive features such as locking, quick-release safety strut clamps, 18" dia. x 8" w pneumatic side wheels (lock into position & swivel to change direction), thud pad & net baffle.

- Size open: 18'w x 22'd x 12'h, folds to 18'w x 12'd x 5'h
- Constructed of heavy-duty 2" aluminum tube
- Black heavy-duty #42 weather-treated nylon net with rear net baffle
- 4' x 6' x 4" thick thud pad, vinyl skirt, ricochet padding on all overhead framing
- Leaning bar serves as strut holder

Model #BIGLEAGUECAGE

\$3799.00



Line Drive Portable Batting Cage

High school foldable and portable batting cage. This unit offers "professional" performance to your high school baseball programs.

- Size is 16'6"w x 16'6"d x 12'h
- Folds down to 48" h
- Constructed of 1.9" flo-coated galvanized steel w/ green powder coat finish
- 16" pneumatic wheels
- Oversized rear wheel cranks and swivels for easy mobility
- Includes heavy-duty, #42 knotless nylon weather-treated netting with rear baffle
- Includes 18' of ricochet padding

Model #LINEDRIVECAGE

\$2150.00



Portable Backstop

- Constructed from 2", O.D. flow-coated steel tubing
- Extra width to cover left- or right-handed hitters
- Heavy duty weather treated netting
- 16"D multi-directional pneumatic wheels
- Easy assembly and disassembly
- Double netting behind batter
- Measures 18'w x 12'd x 12'5"h

Model #BACKSTPORT

\$2299.99

JUGS Pitching Machines



JUGS Curveball

- Quick & easy speed adjustment from 20-104 mph
- Simulates both right & left handed pitches
- Throws various types of pitches

Model #JUGSCURVE
\$1825.00

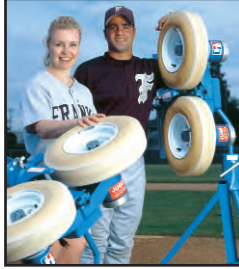

JUGS Combination

- Combo baseball, soft-ball & tennis balls
- Quick change ball chutes
- Speeds 20-104 mph
- Throws various types of pitches

Model #JUGSCOMBO
\$2250.00



JUGS Jr.

- Single wheel machine
- Throws speeds up to 60 mph
- Always-see-the-ball delivery system
- Ideal for pitching machine leagues

Baseball Only
Model #JUGSJRB
\$1175.00

Baseball/Softball
Model #JUGSJRSB
\$1225.00



JUGS Super Softball

- Digital speed control
- Realistic underhand delivery system
- Speeds 15-70 mph

Model # JUGSSUPERSOFTC
\$1450.00
\$1560.00 (w/ travel cart)

JUGS Regular Softball
• Speeds 15-60 mph

Model #JUGSSOFT
\$1175.00
\$1275.00 (w/ travel cart)



JUGS Lite-Flite

For Lite-Flight & Poly baseballs, Poly softballs

- Adjusts for various types of pitches
- Now throws 11" & 12" Lite Flite softballs
- 360° movement
- Left-& right-handed pitches
- Patented "always-see-the-ball" delivery system

Model #JUGSLITE
\$350.00



JUGS Small Ball Machine

- Throws new Jugs 5" small ball up to 75 mph
- Adjustable legs for height
- Baseball/Softball
- 25 ball feeder

Model #JUGSSMBM
\$225.00



JUGS Baseball 18 Ball Feeder

For Curveball, JR., & Combo

Model #JUGS18BBFEUDE
\$475.00

JUGS Softball 14 Ball Feeder

For Softball, Super Softball, Jr., & Combo

Model #JUGS14SBFEUDE
\$475.00



Lite-Flite Feeders & Battery Pack

18" Ball Baseball
Model #JUGSLFEEDB
\$199.00

14" Ball Softball
Model #JUGSLFEEDSB
\$199.00

Rechargeable battery pack for Lite-Flite
Model #JUGSRBP
\$185.00



JUGS Pitching Machine Cover

Model #Jugscover
\$52.00



JUGS Toss Machine Baseball or Softball

Model #JUGSTOSSBB
\$210.00

With remote

Model #JUGSTOSSBBR
\$225.00



JUGS Travel Cart

Transport your softball pitching machines more easily. For regular & super softball machines only.

Model #JUGSTRV
\$160.00

JUGS Pitching Machines Balls



JUGS Small Ball Bucket
 • Small 5" balls (white)
 • 48 balls in bucket

Model #JUGSSMBB
\$39.00

Small Ball Yellow
Model #JUGSSMBBY
\$39.00



Baseballs
Model #JUGSPEARL
\$43.00/doz.

Model #JUGSPEARLBUC
\$158.00/Bucket

Pearl Balls
 Full grain leather cover
 cork center. "Never
 Break" technology. 1 yr.
 guarantee on seams.



Baseballs
Model #JUGSBLF
\$18.00/doz.

Softballs-12"
Model #JUGSBLF12
\$27.00/doz.

Softballs-11"
Model #JUGSBLF11
\$27.00/doz.

Lite-Flite Balls
 Sting Free, use in
 any JUGS pitching
 machine, balls throw
 true at regulation
 pitching distance.



**Sting Free Dimpled
 Softballs, 11"**
 Sting Free, dimple,
 white/yellow

Model #JUGSBBALLS
\$37.00/doz.



**Sting Free Dimpled
 Baseballs**
 Sting Free, dimple,
 white/yellow

Model #JUGSBBALLS
\$27.00/doz.

Iron Mike Machines

Please specify baseball or softball



Deluxe Iron Mike with Hopper (MP-6)

Same as Deluxe Iron Mike except includes ball hopper for 600 baseballs. No transport wheels, permanent mounting. Weight 600 lbs. (motor freight)

Model #IRONMIKEMP6

\$2999.00

Pro Iron Mike with Hopper (MP-4)

Same as MP-6 except includes extra reinforcement on the frame of the machine to protect against batted balls. Also includes positive feed ball delivery. Weight 625 lbs. (motor freight)

Model #IRONMIKEMP4

\$3399.00



Deluxe Iron Mike (MP-5)

Heavy duty hand and arm system simulates wind-up and delivery just like a real pitcher from 25-85 mph. Operates on 110V power with 80' low voltage remote switch. Includes 4 wheel transport system. Ball rack holds 38 baseballs. Size is 56" H x 30"W x 55"L. Weight 480 olbs. (motor freight)

Model #IRONMIKEMP5

\$2479.00

Accessory Weather Covers

For MP-5 **Model #IRONMIKEMP5CV**

\$150.00

For MP-4 **Model #IRONMIKEMP4CV**

\$195.00

For MP-6 **Model #IRONMIKEMP6CV**

\$195.00

SportPanel

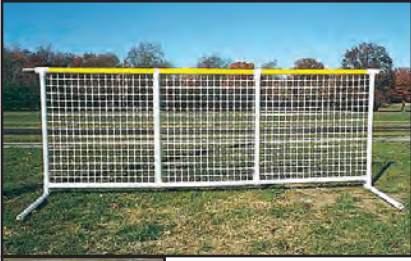

Designed for port-ability, SportPanel outfield fencing is light-weight, durable, weather resistant and economical. The system expands to meet nearly any size requirement. Each fence panel comes completely assembled and includes free foam connectors and anchoring wickets. Constructed of UV inhibited PVC pipe with polypropylene mesh. Stacks neatly and compactly for storage. Panels are 44" high x 10'6" long.



SportPanel White Techno-Tip
 SportPanel Black Techno-Tip
 SportPanel Optional Top Rail Cap
 SportPanel Foam Connectors
 SportPanel Wickets
 SportPanel Foul Pole 15" w x 7'6" h

Model #SPFW \$120.00
 Model #SPFB \$118.00
 Model #SPYTC \$8.95
 Model #SPFC \$24/doz.
 Model #SPWIC \$18.95/doz.
 Model #SPFP \$125.00

Enduro Fencing

Enduro Fencing With Yellow Top Tape

Sets a new standard for simplicity, durability and appearance!

Slide the poles through permanent vinyl pockets in the mesh fencing and drive the pole into the turf with a rubber mallet. No ropes, ties, clips, hooks, etc. Vinyl pockets, spaced every 10', create an attachment to the pole that is uniform top to bottom. Steel pilot hole tool included for hard ground. Optional ground sockets available.



OnePiece Enduro Fence System

Fabricated in one piece to create a homerun fence w/o gaps or overlap. Your System will include a single piece of fencing with pockets, poles, a pilot hole tool for hard ground and a 300' tape measure to assist with proper pole layout. Ground sleeves are optional. Comes in Dk Green only.

200' Homerun Fence (One Piece Enduro Fence System)

314' of fencing, 32 poles, pilot hole tool, tape measure

Model #PINENDURO200 \$1299.99

Optional set of 32 ground sleeves/caps for 200' Homerun Fence

Model #PINENDUROOPTION32 \$198.00

300' Homerun Fence (One Piece Enduro Fence System)

471' of fencing, 48 poles, pilot hole tool, tape measure

Model #PINENDURO300 \$1849.99

Optional set of 48 ground sleeves/caps for 300' Homerun Fence

Model #PINENDUROOPTION48 \$295.00

Measuring Plate

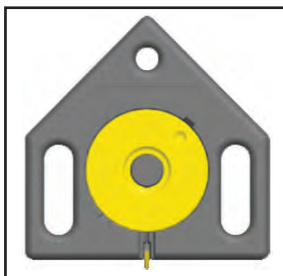
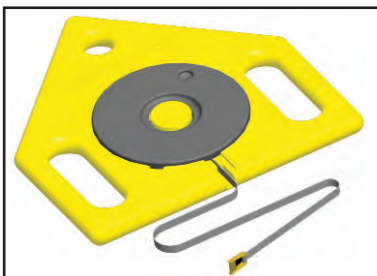

The Measuring Plate

Perfect for all levels of play--baseball and softball

- Adjustable 60'6" fiberglass measuring tape
- UV weather resistant rugged plastic
- Lightweight
- Measure exact distance for practice or games

Model #MPlate

\$49.95

Field Maintenance Equipment

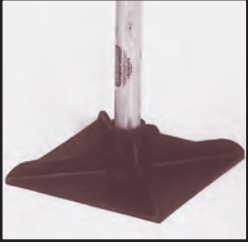

Soil Tamp

Excellent for packing fill dirt around home-plate and mound area. Tamp is made of a steel plate 10" x 10" with a 48" handle.

Model #SOILTAMP

\$48.00



Heavy Duty Tamp

Welded all steel construction with 10" square steel plate. This is one of the most durable tamps available.

Model #HDTAMP

\$58.00



Tamp Sock

Designed to make tamping wet clay a simple hassle free process. Keeps dirt from sticking to your tamp. No more towels taped to the base of your tamp or constantly moving pieces of cloth around your mound.

Simply slide the tamp sock over your tamp base and connect the Velcro on top. Constructed of 3-ply denim for extra durability. 10"x10"

Model #TSOCK10 \$25.00



Loop/2 Way Hoe

Dual action hoe cuts grass and weeds out by the roots with minimal surface disruption. Great on base paths! Heavy duty stamped steel head with wood handle.

Model #2WAYHOE

\$34.00



Puddle Pillows

Reduce the time it takes to remove water puddles from your field. Puddle Pillows can be used time and time again. Simply

place in standing water, when saturated, remove, squeeze dry. Pillows are seamed in the middle creating 2 "pockets" which allows the pillows to be hung over the fence to dry. 10 pillows per case, each pillow can absorb up to 3.5 liters of water.

Model #PUDDLEP Case of Ten \$74.95



Cleat Cleaner

Rugged all rubber construction will de-mud cleats quickly to provide better traction. Can be mounted to treated wood and buried

in the ground for permanent installation.

Model #CLEATC \$27.50



Infield Rake

Features heavy-duty aluminum handles and heads with large teeth on one side and a

rugged leveling blade on the other.

24"-Model #INFIELD24

\$40.00

36"-Model #INFIELD36

\$45.00

48"-Model #INFIELD48

\$52.00

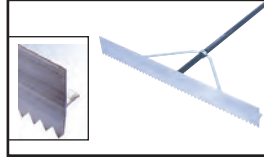

Scarifier/Lute

Features heavy-duty aluminum handle and 36" head, pointed scarifying teeth for

more effective digging. Leveling blade, too.

Model #SCARIFIERLUTE

\$59.00

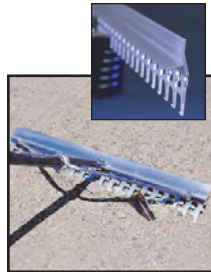

Screening Rake

Features heavy-duty aluminum handles and 36" heads. Specially designed "S" teeth are ideal for sifting/screening stones and debris. Other side features a small leveling edge.

Model #SCREENINGRAKE

\$59.00



Monster Broom

This broom is powerful and has amazing versatility. Heavy-duty aluminum construction. Available with two bristles. Bristles are removable for easy replacement or for adjusting the broom's stiffness.

Model #MBROOM

\$175.00



Double Play Monster Broom

Double play monster broom comes with an aggressive scarifying edge for breaking up packed soils.

Model #DPMBROOM

\$230.00



Diamond Pump

Remove standing water from ball diamonds at 20 gals./ min. with the durable ABS constructed Diamond Pump. Base disk prevents worry from debris. pump is completely unaffected by mud.

Model #DIAMOND

\$89.00

50' Hose Attachment

Model #DIAHOSE50

\$75.00

Finishing Mops



Designed for those small areas that are nearly impossible to finish groom! Great for mounds, infield edges, base paths, on deck circles and any other cutout. The 24"W x 18"D mats are available in your choice of either a high quality cocoa or a heavy-duty flexible steel. The 66" powder coated handles & attachments are constructed of heavy-duty reinforced aluminum.

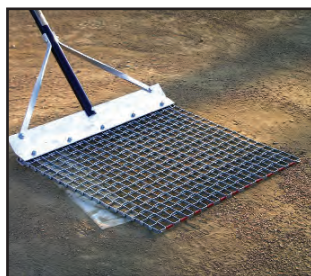

Cocoa Mop Model #COCOAMOP \$108.00

Flex Steel Mop Model #FLEXSTEELMOP \$96.00



Nail Drag
Heavy-duty field conditioner can be used two ways. With the bolts turned down the Field Conditioner easily

breaks up the hard packed areas and with the angles turned down it smooths a 6 foot wide path. The extra heavy chain link fencing attached to the back helps break up the larger dirt clods. The Field Conditioner is designed to hold common 8" concrete block for added weight

Model #FMNAILDRAG \$275.00



Big League Style Nail Drag

Breaks up hard compacted infield clays. Nails are 4" apart & offset creating 2" scarification. Add weight to increase depth. Optional wheel kit adjusts the drag depth & raises for towing. Steel construction.

3'Lx3'W Model #BLND33 \$319.00

3'Lx5'W Model #BLND53 \$449.00

Optional Wheel Kit Model #BLNDWK \$150.00

Cocoa Mat Drags



Constructed from natural cocoa fibers that "float" across the surface producing a beautiful finish with minimal movement

and buildup of your infield mix. Unlike steel drags, cocoa mats drastically reduce the accumulation of dirt when you're finished. Flip the drag over and use the solid steel twin bladed cutting edge for shaving off high spots and filling in the low. Features a hand hold for easy transport. Note: 2' deep drags include a tow rope with wood handle, and the 4' deep drag includes a HD tow chain at no additional cost.

4'Wx2'D Model #COCOA42 \$139.00

6'Wx2'D Model #COCOA62 \$179.00

6'Wx4'D Model #COCOA64 \$260.00

Mound Builder



Takes the guess work out of mound construction—in 8 simple steps your mound will meet all regulations. All steel construction, sliding cross bar, pointed

rods for proper height and radius points for the rubber, mound and turf edge.

Model #MOUNDB10 \$169.00

Model #MOUNDB8 \$169.00

Model #MOUNDB6 \$160.00

Drag Mat

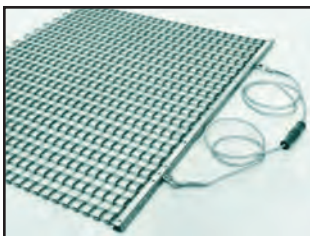

Rugged, continuous-crimp flexible galvanized steel. Ideal for dragging ballfield diamonds and soil preparation for seeding.

3' w x 3' l

Model #FMMAT3X3 \$89.00

3' w x 5' l Model #FMMAT3X5 \$110.00

4' w x 5' l Model #FMMAT4X5 \$135.00

6' w x 3' l Model #FMMAT6X3 \$135.00

6' w x 6' l Model #FMMAT6X6 \$215.00

8' w x 6' l Model #FMMAT8X6 \$360.00

Other sizes available upon request.

Drag Lite



Industrial rubber mat won't rust or kink. Serrated & smooth edges on lead bar (scarifier) to cut or smooth surfaces. Pull chain included.

Available in 3' or 6' widths.

3'Wx2'D Model #DRAGLITESM \$189.00

6'Wx2'D Model #DRAGLITELG \$325.00

Field Maintenance Equipment



Econo Batter's Box Templates

Made from 1" galvanized tubing. Sturdy, light-weight template assemblies and disassembles

easily for convenient storage. Templates fold inward with a push of a button. This very affordable template is available in three different sizes.

4'x6' Baseball

Model #SDBBT46 **\$79.50**

3'x6' Youth Baseball

Model #SDYB36 **\$79.50**

3'x7' Softball

Model #SDS37 **\$79.50**

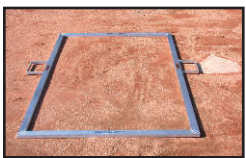

Heavy Duty Batter's Box Template

Constructed from rust-proof aluminum channel. Line up the "easy-guide" handle with the side of

your home plate, follow up with your chalk marker, and you're done! Folds in half for convenient storage.

4'x6' Baseball

Model #HDB46 **\$168.00**

3'x6' Youth Baseball

Model #HDBBT36 **\$168.00**

3'x7' Softball

Model #HDSB37 **\$168.00**



Big League Stadium Hose

This all-purpose water hose is extremely durable & lightweight for easy handling. Weighs 30% less than red rubber

hose. Constructed from high pressure, clear PVC featuring woven polyester cord reinforcements. Rated at 150 PSI working pressure and 450 PSI burst. Available in 1" I.D. only Also available in red.

50' Model #BLSH50 **\$99.00**

75' Model #BLSH75 **\$149.00**

100' Model #BLSH100 **\$179.00**

150' Model #BLSH150 **\$249.00**



High-Impact Fire Nozzle

Thermoplastic construction features a rubber bumper guard to protect the housing; brass diffusers to allow adjustment from light mist to powerful jet stream

Model #HIFN

\$22.95



Adjustable Batter's Box Template

This "universal" template is adjustable for 3x6, 3x7 and 4x6 to accommodate all ball fields. Adjust to your proper league, align the handle with the side of home plate & your guide is correct. Strong, galvanized steel construction

Model #ABBT

\$155.00



E-Z Batter's Box Chalker

Mark a regulation batter's box in less than 60 seconds. Simply fill the trough with chalk, line the unit up with home plate, bump the ground, turn around, repeat the process and you're finished. Marks a 2" wide line. Durable lightweight aluminum construction is easy to transport and will last for years. Features folding handles for space saving storage. Two sizes to choose from: 4'x6' baseball and a combination 3'x7' softball/3'x6' youth baseball.

4'x6' Baseball

Model #EZBBC46 **\$299.95**

3'x7' Sftbl/3'x6' Youth Bsbl

Model #EZBBC37 **\$299.95**



Heavy-Duty Water Hose

Heavy-duty hose constructed from premium components for years of trouble-free performance. Solid brass fittings, 100

PSI working pressure, reinforced hose with 600 PSI burst rating. High visibility red color.

50', 3/4" dia Model #HDWH50-3/4 **\$96.00**

50', 1" dia Model #HDWH50-1 **\$115.00**

75', 1" dia Model #HDWH75-1 **\$159.00**

100", 3/4" dia Model #HDWH100-3/4 **\$189.00**

100", 1" dia Model #HDWH100-1 **\$199.00**

150', 1" dia Model #HDWH150-1 **\$288.00**



Stadium Hose Cart

Affordable hose cart that takes the hassle out of watering your infield. Easily holds 150' of 1" hose. Heavy-duty construction features: heavy gauge tubular steel framing, a baked enamel finish, "EZ turn" hand crank,

wide pneumatic turf tires for easy transport. Includes a 6' x 3/4" feeder hose for connection to your water faucet.

Model #STADHC

\$199.00

Field Maintenance Equipment

Super-Net dry-line marking machines are institutional strength quality made with heavy-gauge cast aluminum body, cast aluminum axle housing, finger-tip control lever for 2" or 4" lines, top lid guide-line (visual aid when lining), cast aluminum paddle wheel with 9 fins for continuous material flow and an 18 month warranty.



All Star

Improved design to meet your toughest demands!

- 100 lb. capacity
- (4) 10" diameter x 4" wide pneumatic rubber tires with diamond tread
- 2nd stage shaker/agitator
- Adjustable handle-37", 39", 41"
- "Sweet spot" flow control dial

Model #ALLSTAR

\$299.00



Heavy Hitter

Improved design to meet your toughest demands!

- 60 lb. capacity
- (4) 10" diameter x 4" wide pneumatic rubber tires with diamond tread
- 2nd stage shaker/agitator
- Adjustable handle-37"/39"/41"
- "Sweet spot" flow control dial

Model #HEAVYHITTER

\$249.00



Get up to 360' of 4" wide line per can!

White Line Aerosol Paint

Specially formulated to produce bright, durable lines. Available in both athletic and traffic/parking lot formulas. Athletic paints are completely safe for players and will not harm grass. **Low VOC's, low toxicity, no fluorocarbons and lead free.**

(12) 20 oz. cans per case (18 oz. net wt/can).

Athletic Paint

Available in White, Hot Orange, Yellow, Blue, Red, Turf Green, Light Blue and Black

White \$43.00
Colors \$45.00

Traffic Paint

Available in White, Yellow, Red, Dark Handicap Blue, Light Handicap Blue and Black

White \$46.00
Colors \$48.00

Call for volume discounts of multiple cases of Athletic Paint.

Average use for aerosol paint:

Football	2 cans	4" line
Baseball	3 cans	3" line
Soccer	6 cans	4" line



← **Universal Tip-**
Works with most paint stripers, including Fox Valley



Little Tuffy

Improved design to meet all your demands!

- 60 lb. capacity
- (2) 10" diameter x 4" wide pneumatic rubber tires with diamond tread
- 2nd stage shaker/agitator
- Adjustable handle-37"/39"/41"
- "Sweet spot" flow control dial

Model #LITTLETUFFY

\$210.00



Dasher Pro

Improved design to meet all your demands!

- 25 lb. capacity
- (2) 10" diameter x 4" wide pneumatic rubber tires with diamond tread
- Loop handle with hinged lid

Model #DASHER

\$109.00



White Line Stripers

One of the most versatile and durable aerosol paint stripers in the industry. The universal spray tip activator works with nearly every brand of paint, including Fox Valley. The heavy-duty construction boasts a durable all-metal

body, a folding handle for storage and transport, rubber tread tires and a bottom wind block to prevent overspray. The spray width is fully adjustable and stripes a 2" to 4" line. For operator convenience, we also have a built-in storage tray for easy access. Available in an athletic version with 10" wheels and a traffic/parking lot version with 7" wheels.

10" wheel
Model #APSM

\$89.00

7" wheel
Model #TAPSM

\$89.00

Poly Cap



Bright Yellow Poly Cap

An inexpensive way to add safety, reduce player injuries, increase visibility and beautify any park. Weather treated and U.V. protected 4-1/2" diameter poly-ethylene will offer years of protection. Limited two year warranty. Cut, slit and ready to install. Please specify green or yellow.



Yellow Poly Cap

100'-Model #POLY100

\$99.00

250'-Model #POLY250

\$159.00

Green Poly Cap

100'-Model #POLY100

\$99.00

250'-Model #POLY250

\$159.00

18" Reusable Ties

Model #POLYTIE

yellow 100/ \$28.00

black 100/ \$28.00

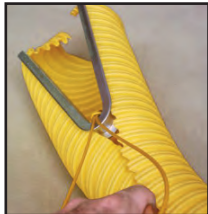

Poly Cap & E-Z Pro Installer

Cuts installation time by up to 75%. Simplifies installation & avoids injuries by spreading capping & allowing it to close over the fence as you move forward. Steel Construction, can be used over & over.

Model #CAPINTS

\$29.95

Safety Top Cap



Unique design provides protection against bodily injury. Simply snap over the top of the fence and lock to the wire mesh with steel hog-rings (included with each package) through the three pre-drilled holes on each piece. Primarily used in our Safety Yellow color for baseball outfields. 5 pieces, 8' long, 40' total.

- Durable and flexible plastic in an open tubular shape
- Designed to endure high impact, resist the harmful effects of the sun & withstand severe weather

Model #SAFECAP

\$79.99



Fence Guard



Fence Guard is a more durable way to protect against player injuries, increase visibility and beautify any park. Manufactured of U.V. resistant polyethylene. Each carton contains fifty

UV-resistant ties to attach product. Five year manufacturer's warranty. Available by the carton only. Premium Fence Guard available in the following colors (please specify) yellow, dark green, scarlet, and royal. Standard available yellow, dark green, scarlet, royal, orange and white.

Premium Fence Guard™

3" w x 4-1/2" h x 8'l, .09 wall thickness

Carton: 10 pieces 8' long—80 linear feet

Model #FENCEGUARDPR

\$170.00

Standard Fence Guard™

2-5/8" w x 4" h x 8'l, .07 wall thickness

Carton: 10 pieces 8' long—80 linear feet

Model #FENCEGUARD

\$111.00

Lite Fence Guard™

2-5/8" w x 4" h x 8'l, .05 wall thickness

Carton: 10 pieces 8' long—80 linear feet

Yellow, Dark Green, Red, Blue only

Model #FENCEGUARDLT

\$71.00

Outfield Distance Markers

Outfield distance markers are printed digitally with 14 oz. reinforced vinyl fabric. Available numbers and background colors of your choice. Banner colors: Forest Green, Red, Yellow, Royal Blue, Gray, Tan and Black. Numeral colors: White, Yellow, Black and Blue.



27" h x 36"

(14" numbers)

Model #OUTFIELDDM14

\$63.00



56" h x 20"

(12" numbers)

Model #OUTFIELDDM12

\$59.00



38" h x 56"

(24" numbers)

Model #OUTFIELDDM24

\$69.00

Field Protection

Features: high-quality, high-tensile strength; superior ultra-violet resistance; 1/3 the weight of conventional tarp; a heat reflective finish that allows the tarp to stay on longer. Various weights & sizes available. Same as used by professional clubs. Call for pricing & samples. *Cover all your bases with our field cover kits!*



Full Field Covers

High quality, high-tensile strength, UV protection, pull straps every 12' on all sides; Available in silver/white. 2 year warranty. Custom sizes available. Call for freight and prices

Size	Model #	7.3 oz.
90 x 90	FFC90X90	\$1150.00
120 x 120	FFC120X120	\$2000.00
160 x 160	FFC160X160	\$3475.00
170 x 170	FFC170X170	\$3950.00



Field Cover Rollers

Heavy-duty 28" dia. double-wall corrugated plastic rollers for storing your field cover.

- 20'L x 28" OD (1 section) **\$580.00**
- 34'L x 28" OD (2 sections) **\$935.00**
- 40'L x 28" OD (2 sections) **\$1025.00**



Storage Covers for Rollers

- 20' **\$160.00**
- 30' **\$239.00**
- 40' **\$299.00**

Storage covers for rollers are available with school names imprinted. Call for prices.

Infield Protection

Infield Protectors

Protect your turf during batting practice. Fits between home plate and the pitcher's mound. This vinyl-coated mesh cover prevents damage to grass, allowing air and sunlight to penetrate. Outside perimeter is hemmed and reinforced with grommets every 3'. Available in green, royal blue, black and red. Custom sizes and shapes available, call for a quote.



Item	Model #	Price Standard Duty	Price Heavy Duty
Protector #1	FPIP#1	\$550.00	\$750.00
Protector #2	FPIP#2	\$390.00	\$500.00
Protector #3	FPIP#3	\$275.00	\$400.00
Protector #4	FPIP#4	\$280.00	\$390.00

Four sizes

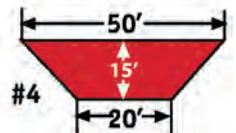
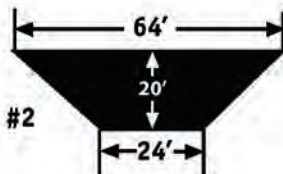
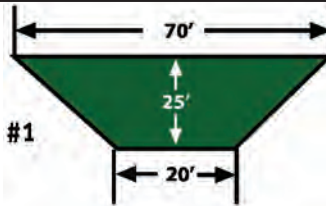

Field Protection

Base Cover Kit

Eliminate rainouts and costly maintenance. Made from the same material as the professional field tarps. Constructed of premium interwoven polyethylene fabric, with U.V. protectors. Rot and cold crack resistant, material and seams are water proof, white/silver color reflects heat build-up. Kit includes: (3) 18' dia. base covers, (1) 20' dia. pitching mound cover, (1) 30' dia. home-plate cover and (35) anchor pegs. Items from the kit are available separately, see chart below for pricing. Also available in 14 oz. forest green vinyl.



Item	Model #	Polyethylene Fabric Price	14 Oz. Forest Green Vinyl Price
Base Cover Kit	FPKIT	\$460.00	\$1140.00
30' Diameter Home Plate Cover	FPHOMEPLT	\$225.00	\$445.00
20' Diameter Pitching Mound Cover	FPMOUND	\$115.00	\$205.00
18' Diameter Base Cover	FPBASE18	\$85.00	\$160.00
10' Diameter Base Cover	FPBASE10	\$39.00	\$70.00
Anchor Pegs(set of 12 same item, both materials)	ANCHORPEGS	\$10.00	\$10.00

Weighted Base Covers

The heaviest weighted cover available. Requires no sandbags or stakes! Made from durable 180z./sq. yd. fabric. Weighted in the hem to stay in place. Colors: Forest Green, Royal Blue, Red, Navy, Gray, Maroon, Sky Blue, Purple, Yellow, White, Tan, Black, Kelly Green, Orange

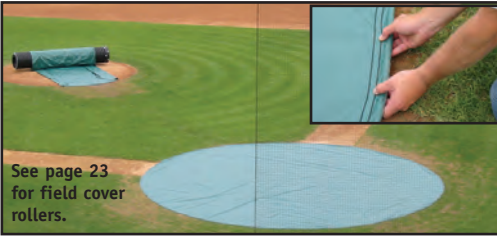

Stock Sizes	Model#	Price
12' diameter	WBC12	\$235.00
18' diameter	WBC18	\$380.00
20' diameter	WBC20	\$445.00
26' diameter	WBC26	\$660.00
30' diameter	WBC30	\$781.00
10' x 10' square	WBC10	\$180.00
10' x 10' square (set of 3)	WBCS12	\$525.00

Radar Guns



JUGS Pro Sports Radar Gun

- Digital signal processing
- Accuracy w/in \pm .10 mile
- Speed range 30-150 mph
- Greater distance range up to 300 ft.
- Roll down feature; clocks first and last speeds
- Uses 6 NiMH batteries

Includes radar gun, wall charger, HD soft carrying case. Two year guarantee.

Model #JUGSRADAR

\$769.00

SR3600

- Speed range: 10 to 250 mph in mph or km/h
- Resolution + or - 1 mph
- High-impact resistant; weighs 1.5 lbs
- "Point and Shoot" technology
- Range is typically 60' on balls
- Trigger or continuous modes
- Standard 9v battery operation (2 required)
- Low battery indicator
- 1 year limited warranty
- MADE IN THRE USA!



Model #SR3600

\$287.99

Tracer-SRA3000

- Speed range: 5 to 199 mph in mph or km/h
- "Point and Shoot" technology
- Range is typically 60' on balls
- Trigger or continuous modes
- Average speed statistic
- operates on (6) AAA alkaline batteries
- Includes soft case and speed tuning fork
- 1 year limited warranty

Model #SRA3000

\$176.99



Wall Pads—Indoor or Outdoor



Exterior Wall Pads



Interior Wall Pads

Ball Stop Pads

Ball Stop Pads are pads used primarily to control erratic ball bounces off concrete, wooden walls, or chainlink fences. Typical areas for this type of padding are directly behind home plate, gym walls and stadium walls. Provide maximum protection against unavoidable wall collisions. Easily installed. Vinyl fabric available in ten different colors. Can be used indoors or out. **Price quotes on request.**

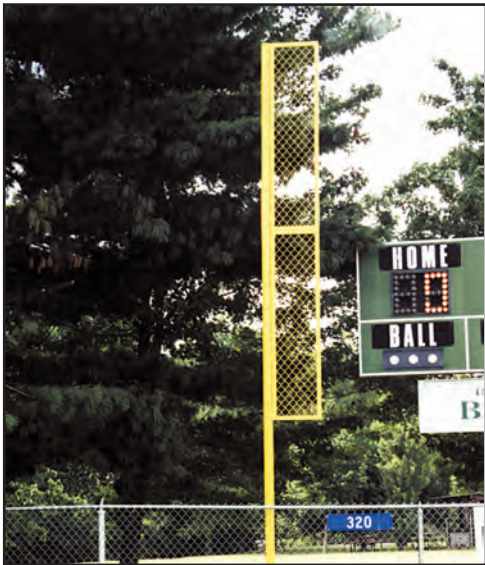

Heavy-Duty Foul Pole

20' Above Ground

Leave the guessing out of calling foul balls with our heavy-duty foul pole. Painted optic yellow to make it easy to see during day or night games. Constructed of heavy-duty 3 1/2" OD heavywall steel pipe with a 1' 6" x 12' visual swing on the top of the 12' of the poles. 20' of the units are above ground and 4' are inserted in the ground.

Model #FP525

\$975.00/pair

30' Above Ground

This heavy-duty foul pole is constructed of 4" O.D. steel pipe with 1-1/2' x 22' of visual wing, 8' above ground. Tough yellow powder coat finish for years of service.

Model #FP527

\$1400.00/pair

Call for other sizes
and double foul poles

Safe Foam Padding

Safe foam pads cover fence tops, rails, post and poles. Premium 3/4" thick with durable skin coating (5 year warranty). Pre-slit for easy installation. Easily cut in the field to fit your application. Choose PREMIUM Colors: yellow, royal blue, red, green, sky blue, purple, gray, black.

Premium 8' Section

Model #SAFEFP

\$28.00/Per 8' Section



Custom Pads—Price quotes on request.



Batting Practice Mats

Super-Net distributes the most popular and durable mats on the market. The mats are heavy duty, easy to handle, and can be used in various places i.e: coaches boxes, batting cages, dugouts, or locker rooms.



Home Plate Mat

Baseball 6' x 12'

- 5mm foam backing
- Line tufted in, not painted
- Permanent home plate—no more paint
- Spike-proof

Model #417012BB

\$320.00

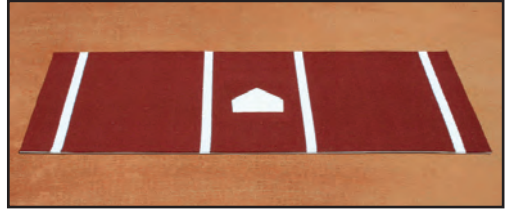

Home Plate Mat

Baseball 6' x 12'

- 5mm foam backing
- Line tufted in, not painted
- Permanent home plate—no more paint
- Spike-proof

Model #418012BB

\$320.00

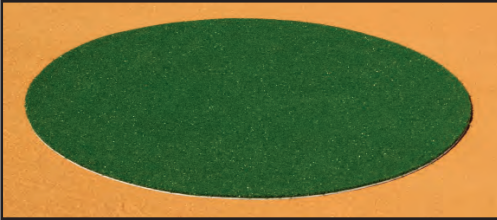

Fungo/ On Deck Circle

- 5mm foam backing
- 6' Diameter

Model #417009FON

\$165.00



Batter Mat

Baseball 4' x 6'

Model# 417018BB

\$110.00

Softball 3' x 7'

Model# 417017SB

\$108.00

Pitcher Mat 6' x 12'

Model#417012PM6

\$280.00

Artificial Turf



Academy Turf

- 40 oz. spike-proof polypro pile
- 5mm foam backing
- Available 12' wide

Model #ACADEMY

\$2.75/sq.ft.



Sport Turf

- 42 oz. Spike-proof polypro pile
- 2mm rubber backing
- Available 15' wide

Model #STURF

\$2.80/sq.ft.

Proper Pitch Pitching Mounds & Mats



On field game mounds convert any regulation softball field into a baseball diamond in minutes. The Game Jr can easily be moved to accommodate different pitching distances.

Features:

- Lightweight, high-strength construction
- Non-slip, non-marking backing
- Regulation specs
- Shock-absorbing landing area
- Easy clean up with water

Game Mound 8'3"w x 11'6"l x 10"h

Model#417004 (green)

\$2025.00

Model#418004 (clay)

\$2025.00

Game Junior 5'4"w x 9'l x 6"h

Model#417001 (green)

\$1199.00

Model#418001 (clay)

\$1199.00

Proper Pitch Pitching Mounds & Mats

Professional Mound



5'4" w x 9'6" l x 10" h
Model#417003 (green) \$1099.00
Model#418003 (clay) \$1099.00

Collegiate Mound



4' w x 9'6" l x 10" h
Model#417002 (green) \$899.00
Model#418002 (clay) \$899.00

Prep Mound



Prep mound designed 6" high for little league players. Can be used on field or indoors.

4' w x 9' l x 6" h
Model#417000 (green) \$749.00
Model#418000 (clay) \$749.00

Junior Pro Mound



Junior Pro Mound is designed for Little League playing. Can be used on field or indoors.

- 42" W x 6'L by 6"H

Model #419002 (green) \$499.00

Model #419003 (clay) \$499.00

Portolite Pitching Mounds & Mats



High-quality mound is the perfect product for indoor pitching. Two-piece design enables easy moving and storage. Simulated rubber will not wear down, scratch or damage expensive gym floors.

- 10" Regulation

Height, 102" l by 48" w

- Total space needed for storage 13" x 48" x 56"
- Overlapping interlock design
- Full body construction
- Level pivot area in front of rubber promotes good balance

The Pro Mound

Model #1PM-2250 \$890.00

The Pro Mound with artificial turf

Model #TPM-1150T \$999.00



This economy pitching mound can convert a softball field into a baseball field in just minutes and eliminate pitching uphill. You can use this mound indoors or outdoors. Use for Practice, Little League, pitching clinics, mobile bullpen or any application where a small easily moveable mound would be an asset.

- 4" h by 46" l by 36" w

- Weighs less than 30 pounds; promotes easy transport
- Economical and durable
- Use indoors or outdoors

The Pony Mound

Model#10P-4434 \$335.00



Turn any softball field into a baseball field in just a few minutes. Simply place the mound at desired distance and rake dirt to edges of mound.

- 6" h by 72" l by 48" w
- Easy to move and to store
- Pitching from an elevation will increase control
- Use indoors or outdoors

The 6" Pony Mound

Model#10P-6672 \$780.00

Proper Pitch Batting Practice

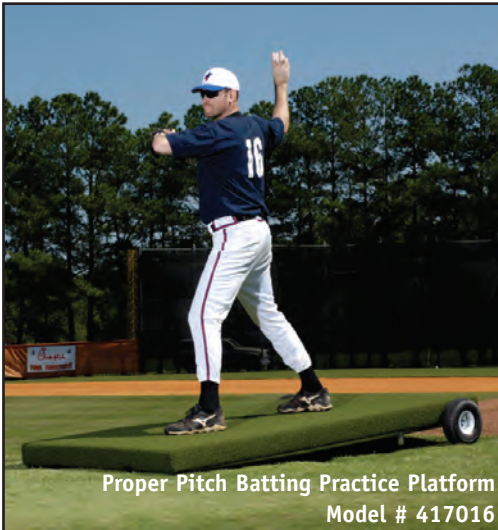

Proper Pitch Batting Practice Platform
Model # 417016

Batting Practice Pitching Platform

Features:

- Protects mound during batting practice
- Won't flatten grass
- Allows airflow underneath to keep grass green
- Durable aluminum frame is light weight and very portable—less than 100 lbs.
- Regulation pitching slope

7'L x 4'W x 10"H

Model #417016

\$799.00

Junior Training Mound

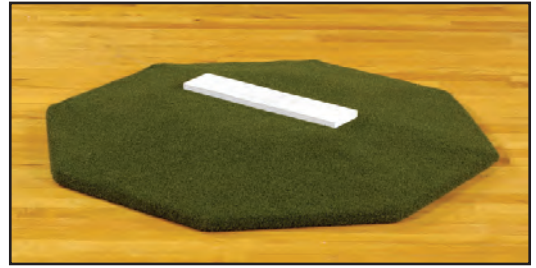

Great for working on mechanics and pickoffs. Portable & lightweight. Take it anywhere use for regular team practice, individual lessons or enhancing your skills in your backyard. 42" w x 42" l x 4" h

Junior Training Mound

Model #419005 (green)

\$319.00

Model #419006 (clay)

\$319.00

Powerline Club K Fastpitch Mat



Powerline Club K Fastpitch Mat

Rubber mat with permanent embedded white lines and pitchers plate. Center line is the actual "power line" which indicates proper foot placement and balance.

Model #CLUBKFM

\$219.95

Softball Pitching Mats

Softball Pitching Mat w/ Stride Line Softball Pitching Mat



Lightweight softball pitching mat with stride line. Made from artificial turf with a non-slip backing that will not mar gym floors. Permanent stride line will indicated the proper foot placement and balance. Portable, easily stored and comes with its own carrying case.

Features:

- 3' x 10', weighs 25 lbs.
- Regulation pitching rubber with stride line
- Economical and durable
- Stays put during practice

Model #4417010

\$210.00

Softball Pitching Mat



Lightweight softball pitching mat is made from artificial turf with non-slip backing that won't mar gym floors. An excellent teaching aid for the correct move to home plate, it is portable, easily stored, and comes with its own carrying case.

Features:

- 3' by 10', weighs 25 lbs.
- Regulation pitching rubber
- Economical and durable
- Stays put during practice

Model #417005

\$185.00

Softball Pitching Mat



This lightweight pitching mat will give your pitchers the feel of the real thing in the gym. Don't tape rubbers to the

floor anymore, get our mat designed for any floor surface! It stays put during pitching practice, and its simulated rubber won't wear down. Plus the reduced rubber height eliminates that "rocking" feeling prevalent with so many mats. Shipping weight: 10 lbs.

- Reduced rubber height
- Weight of less than 10 pounds promotes easy transportability
- Economical and durable
- Stays put during practice

Model #SSM-1145

\$118.00

Rogers Break-Away Bases



Complete base system includes: 3 base tips, 3 base plates, 3 anchor system (anchor housing, anchor sleeves, anchor plugs), 1 dig-out-tool & installation manual.

- Clinical studies have proven that Rogers Bases reduce injuries by 97 percent
- Natural rubber construction of the base tip has different firmness to match level of competition
- Only Rogers offers break-away bases for four levels of play
- Cost-effective

Youth Base System (Male up to 12 yrs or female up to 16 yrs)
Model #RBBS-Y **\$450.00**

Teen Base System (Male 12-16 yrs or female 16-21 yrs)
Model #RBBS-T **\$450.00**

Adult Base System (Male 16 yrs and up or female 21 yrs & up)
Model #RBBS-A **\$450.00**

Pro Base System (Advanced or professional players)
Model #RBBS-P **\$450.00**

Replacement Components Available

Breakaway Base



Magnetic Breakaway Base Set

Complete base includes base cover, stanchion pan, ground inserts and 3 interchangeable plates to adjust holding strength. Meets Little League specifications for 2008.

Model#MBBS **\$275.00**

Base Caddy



Base Caddy

Takes the hassle out of transporting and setting your bases. The cart design is the perfect place to store your bases, helping to extend their life; makes cleaning a breeze. Features heavy-duty galvanized steel construction with 8" semi-pneumatic turf-style tires. Universal design holds both 1" male- and 1 1/2" female-style bases. Includes a convenient digout tool holder and a free digout tool.



Model#BASECD **\$109.00**

Hollywood Bases

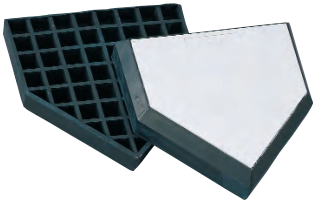

Pro Bury All Home Plate

- High-durability all rubber waffle construction
 - No corners or edges to catch spikes
 - Non-skid rubber surface
 - Waterproof
- Shipping weight: 24 lbs.

Model #CBH86 \$72.00

Same as above with cherry hardwood bottom

Model #CBH88 \$93.00

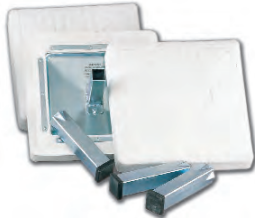

Pro-Style Anchored Base

- Heavy gauge rubber cover
- Sturdy Foam Core
- Great value
- Set includes 3 bases, 3 anchors and 3 plugs

Model #CM500 \$165.00



Pro Double First Base

- Reduces collisions
- One piece molded rubber
- Includes double base anchors

Model #CB175 \$110.00

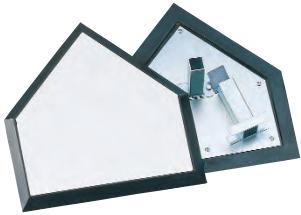

Pro Anchor Home Plate

Pro home plate with anchor

Model #CBH87 \$76.00

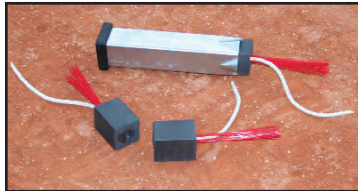

Base Plugs

No more searching for your base anchors! Bristle design fits 1 1/2" Hollywood style anchors.

Model# BASEPL \$4.00/ea.



Anchored Base with Molded Shell

- Molded plastic shell
- Urethane foam filled
- includes 3 bases, anchors

Model #CM250 \$159.00



Dig Out Tool

8" Dig out tool w/ tapered edge

Model #CDT10 \$5.50



Pro Style 4 Way Pitcher Rubber

Pro 4 way pitcher box

Model #CB481 \$72.00



Base Plugs

- Molded rubber base plug
- Fits all conventional inground bases
- Set of three

Model #CM500P \$9.50



Tip N' Roll Bleacher

The Tip N' Roll Bleacher is perfect for indoor/outdoor auxiliary seating requirements. This lightweight aluminum unit easily tips up on its casters for convenient storage. Our high grade swivel casters & rubber foot pads will not mar your floors. Seats & frames are same specs as Stationary Bleachers.



Stationary Bleachers

Frame work is welded aluminum angle. Seat planks are 10" w anodized aluminum & foot planks are 10" w mill-finished aluminum. Available in 2, 3, 4 & 5 row models, 15', 21', and 27' long as described. 4 & 5 row bleachers include chain link system guardrail & risers above seat row 4. Bleachers meet requirements of NFPA & the Consumer Products Safety Commission standards. Some assembly required.

Rows	Model#	L x H x D	Seats	Price
2	TR208	7'6"x24"x36"	9	\$750
2	TR215	15'x24"x36"	20	\$1075
2	TR221	21'x24"x36"	28	\$1475
3	TR308	7'6"x30"x60"	15	\$1049
3	TR315	15'x30"x60"	30	\$1349
3	TR321	21'x30"x60"	42	\$1825
4	TR408	7'6"x30"x81"	20	\$1325
4	TR415	15'x30"x81"	40	\$2025
4	TR421	21'x30"x81"	56	\$2449

Rows	Model#	LxHxD	Seats	Price
2	SB215	15'x24"x36"	20	\$975
2	SB221	21'x24"x36"	28	\$1325
3	SB315	15'x30"x60"	30	\$1375
3	SB321	21'x30"x60"	42	\$1675
3	SB327	27'x30"x60"	54	\$2175
4	SB415	15'x7'3"x7'7"	40	\$2950
4	SB421	21'x7'3"x7'7"	56	\$3550
4	SB427	27'x7'3"x7'7"	72	\$4325
5	SB515	15'x7'11"x9'7"	50	\$3725
5	SB521	21'x7'11"x9'7"	70	\$4725
5	SB527	27'x7'11"x9'7"	90	\$5750

Note: Compliance with local codes are the responsibility of the owner. Contact your local building inspector for local code requirements.

Other sizes and styles of bleachers are available. Please contact us for pricing.

Players Benches



Heavy Duty Aluminum Benches with Galvanized Steel Supports

- **5 Year Warranty!**
- All seats & backs are 10" w anodized aluminum plans with endcaps.
- Frames are heavy duty 2-3/8" O.D. galvanized steel providing superior support to aluminum planks.

Permanent Player Benches with Backs		
Length	Model#	Price
7'6"	PPB75	\$320
15'	PPB15	\$490
21'	PPBB21	\$630
Portable Player Benches with Backs		
Length	Model#	Price
7'6"	POBB75	\$325
15'	POBB15	\$490
21'	POBB21	\$630



Call Now!

1-800-955-NETS
(1-800-955-6387)

*Super-Net is your direct source
for all your sports netting needs!*

Find it fast!

See our full index on page 2.
www.supernetsusa.com

335

800-955-NETS (6387)
Tel: (919)567-3737
Fax: (919)567-1144



3209 Air Park Road
Fuquay-Varina, NC 27526

PPSR1 STD
U.S. POSTAGE
PAID
PERMIT # 212
HICKORY N.C.